

LESSO 联塑

2021 年度中期业绩

企业推介

2021 年 8 月



目录





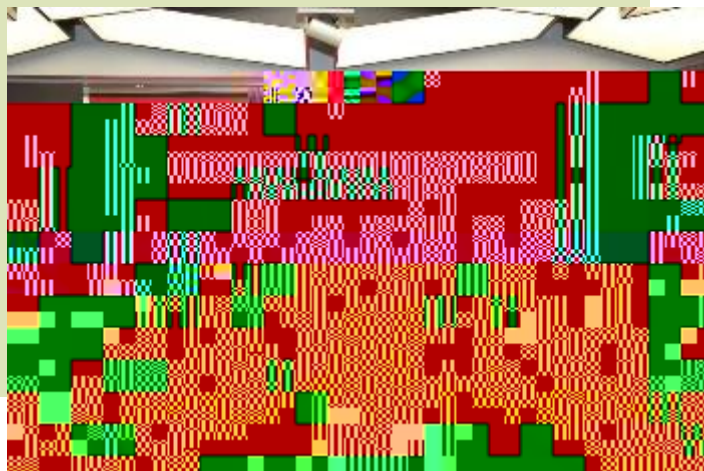

目录





总收入

()

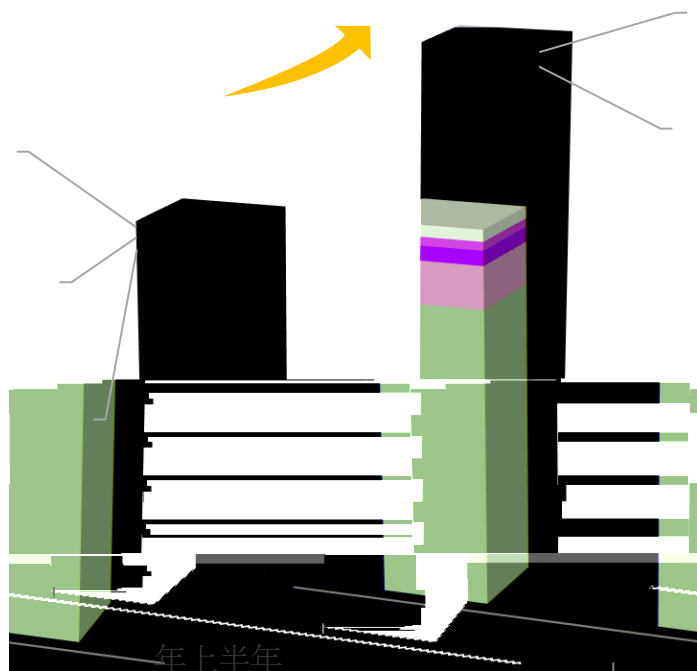

年上半年

年上半年

-
-
- *
- *

分项目总收入按学校类别

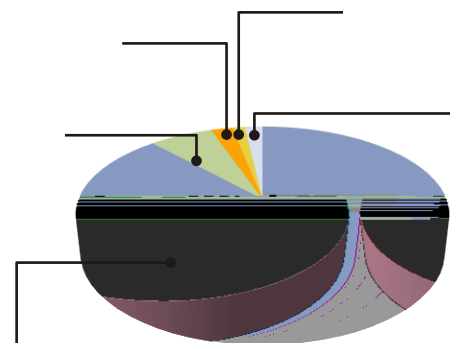
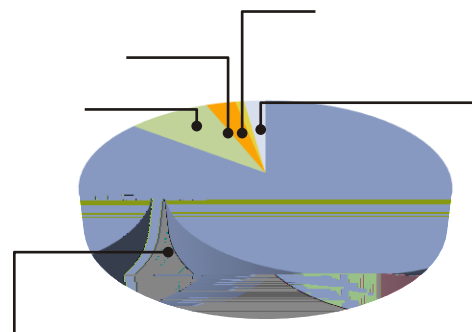



2020年上半年

2021年上半年

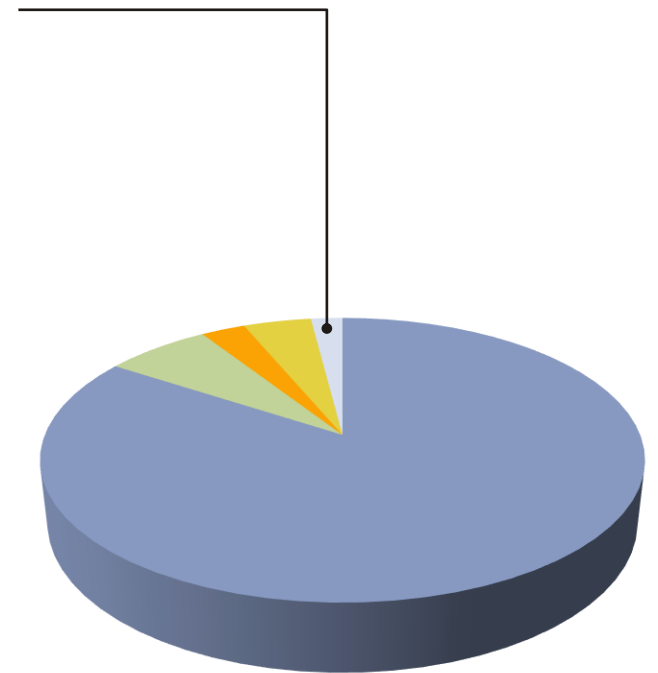



毛利及毛利率

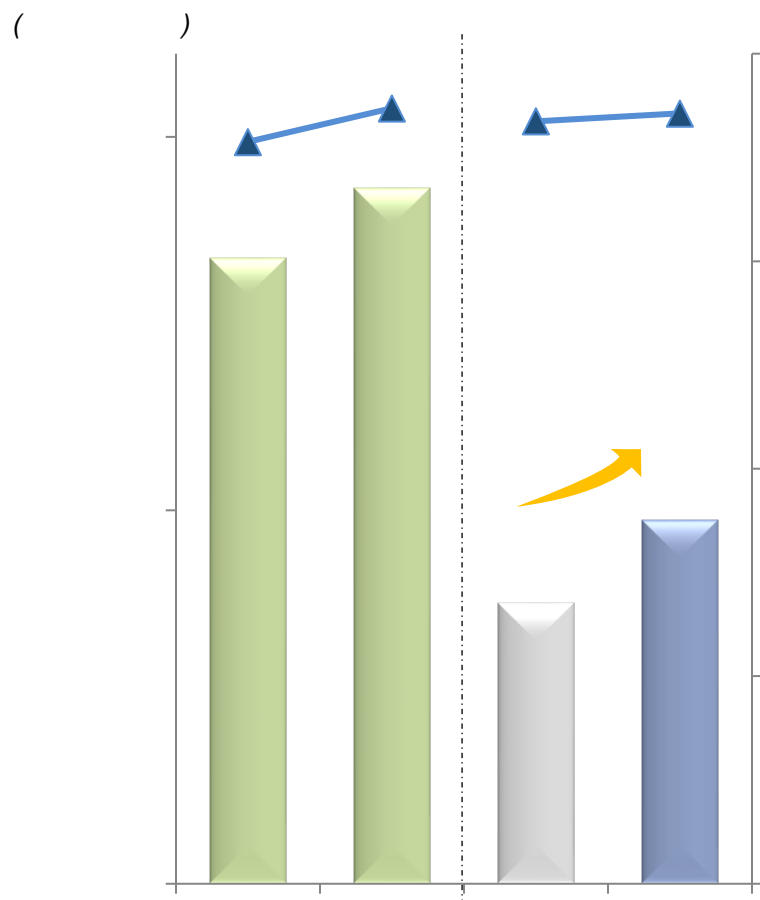

净利及净利率

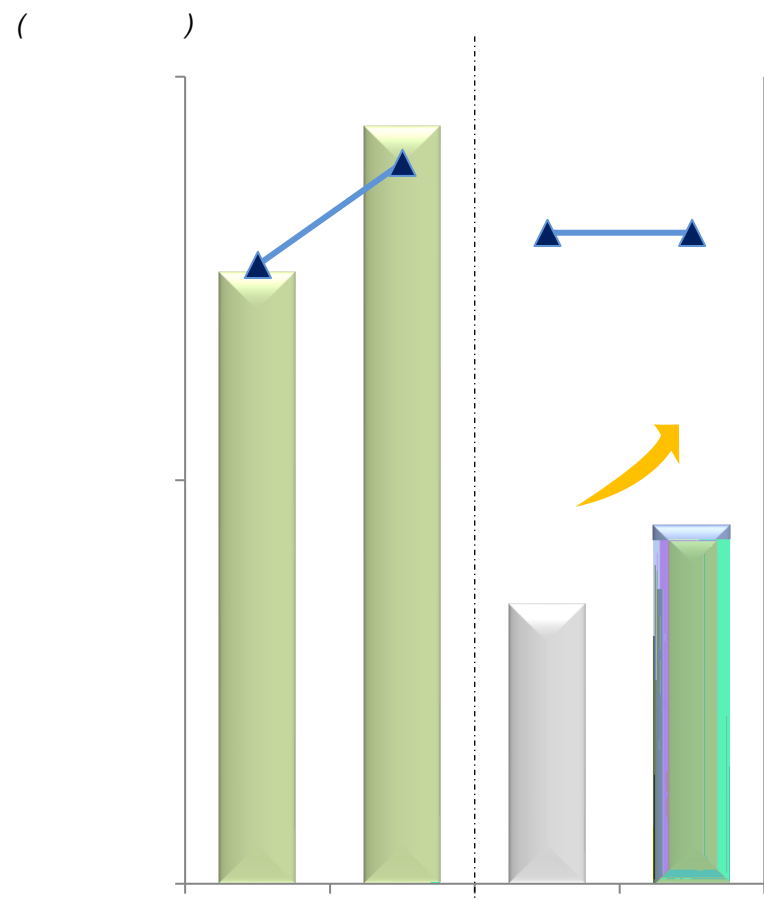



应收账款天数

()

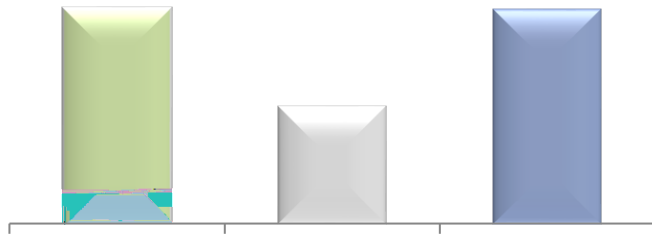

应付账款天数

()

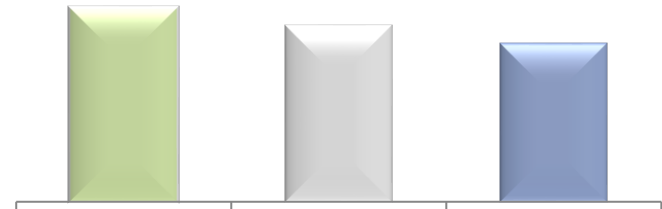

存货周转天数*

()

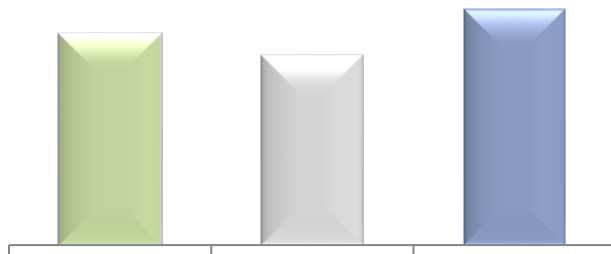

现金与银行存款

()





股权回报率(1)

资产回报率(2)

投资资本回报率(3)

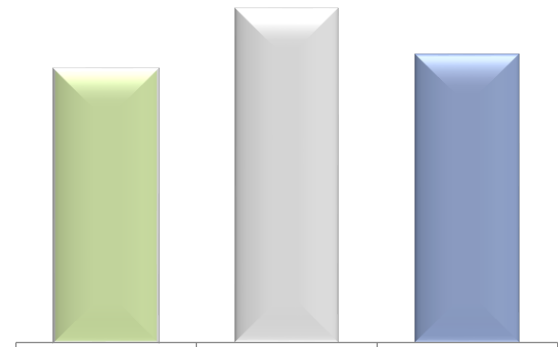
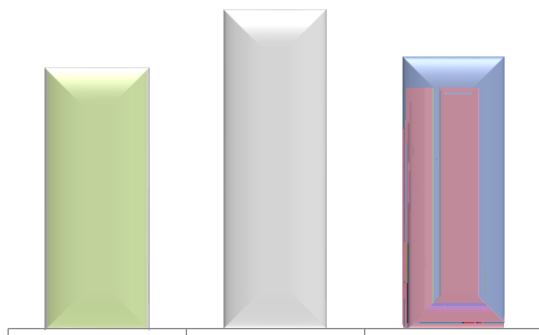
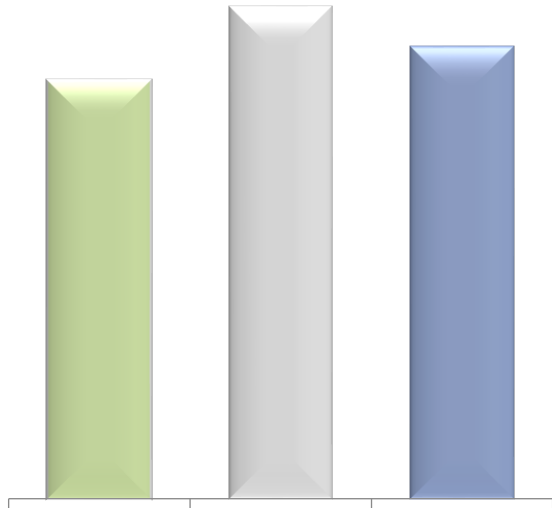

- (1)
- (2)
- (3) ()

目录





分部收入

()

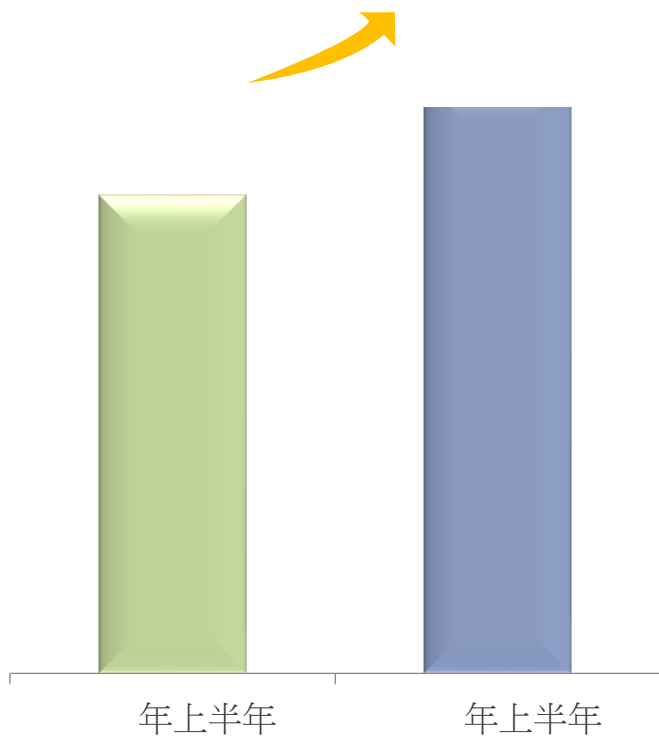

分部损益

()

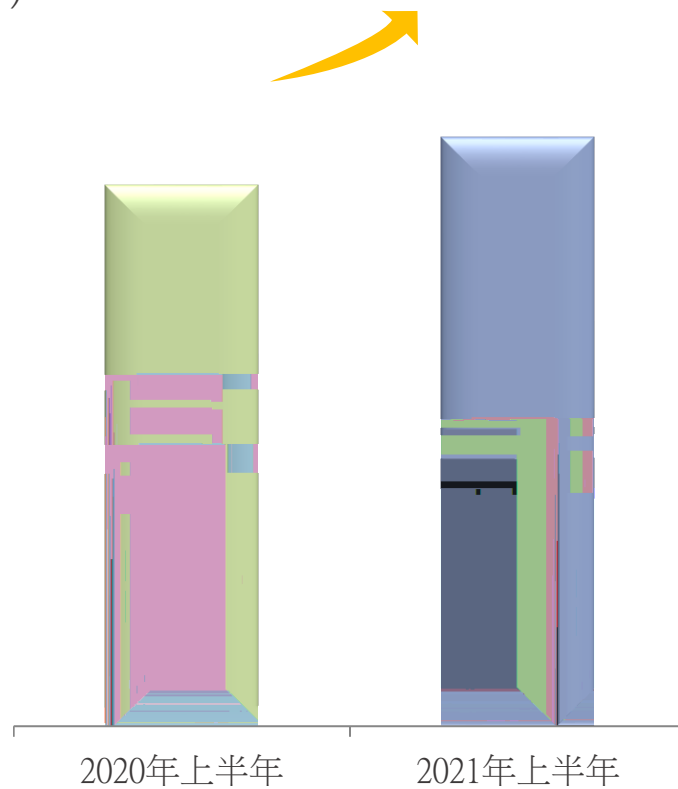

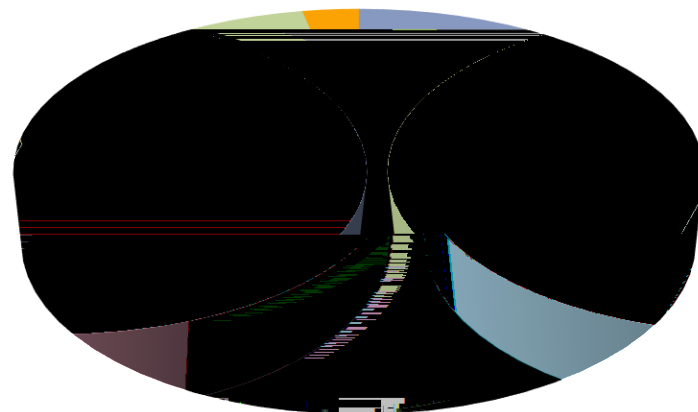

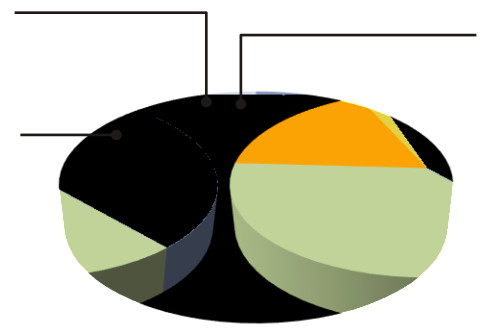
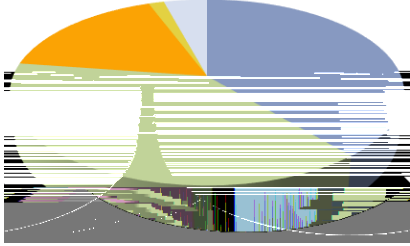

(

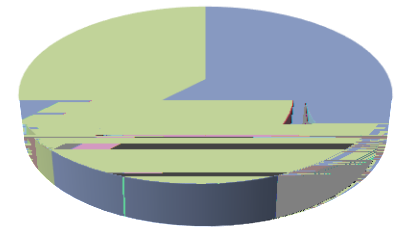
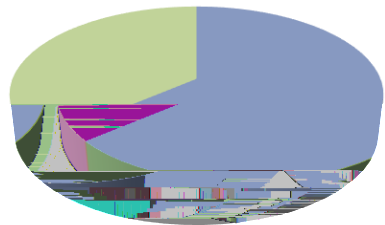



吨平均售价

()

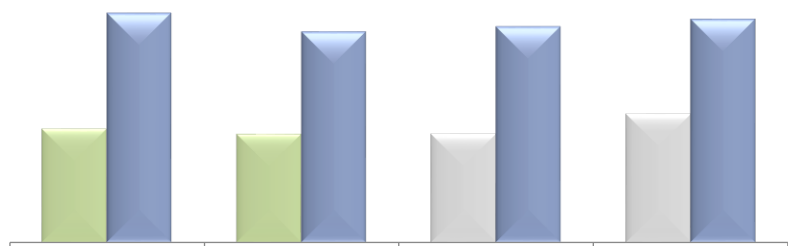

毛利率

每吨平均售价

()

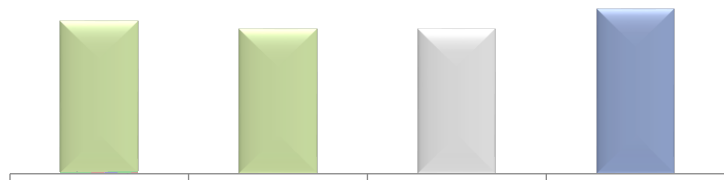

毛利率

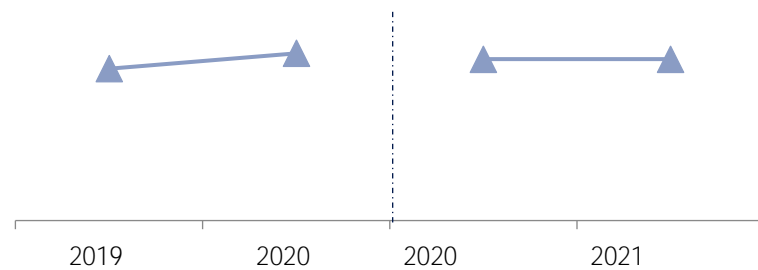



三年设计产能及平均产能利用率

()

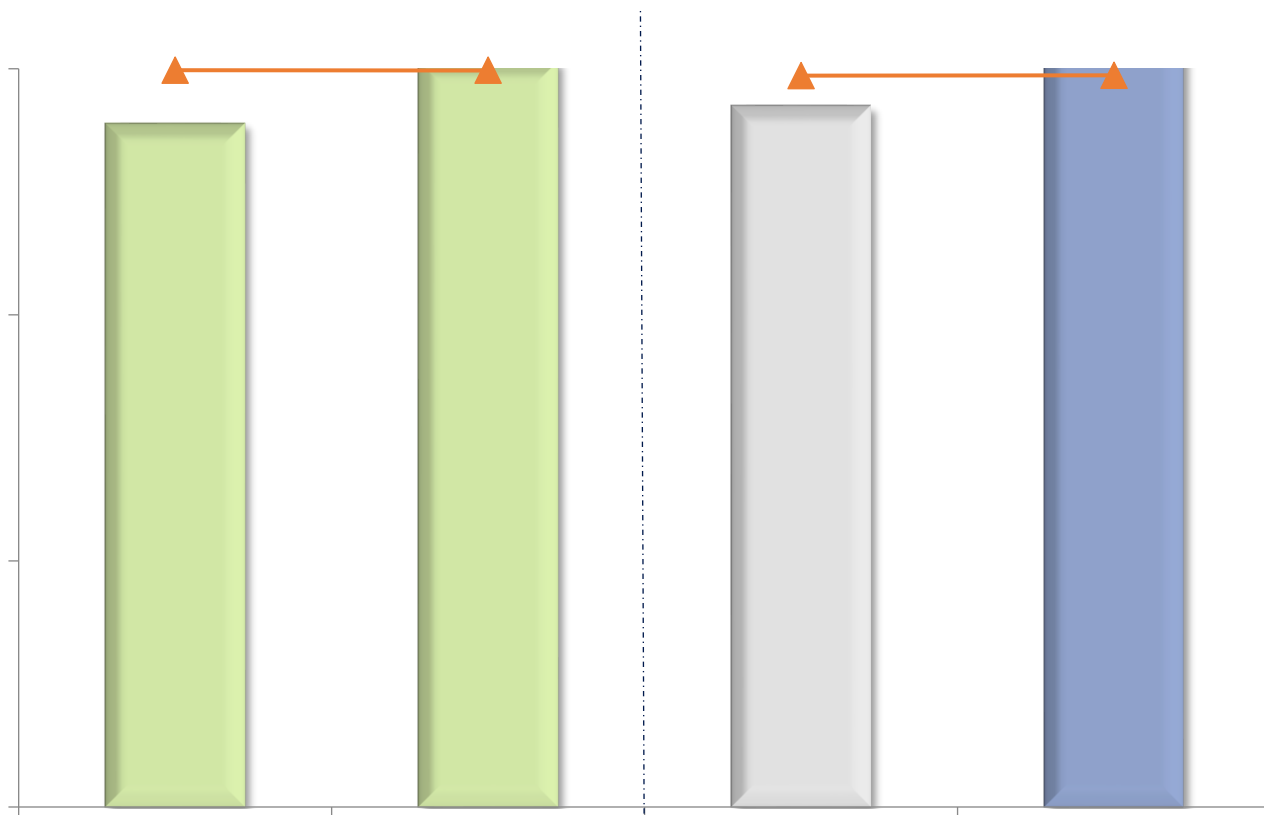

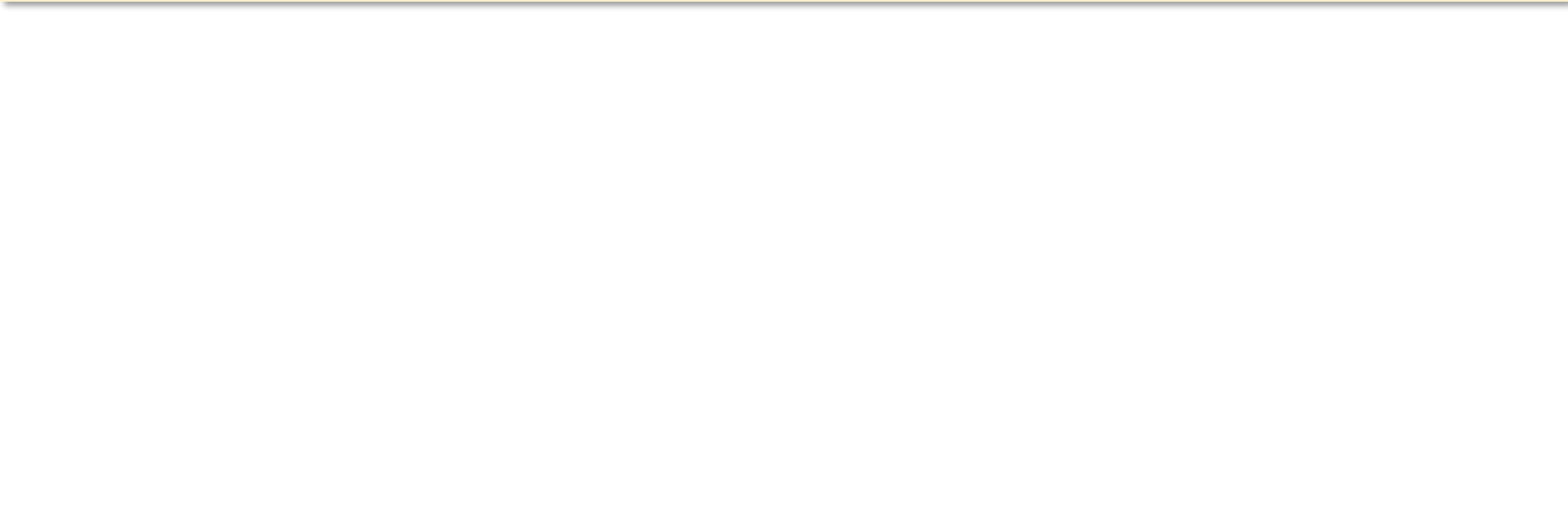



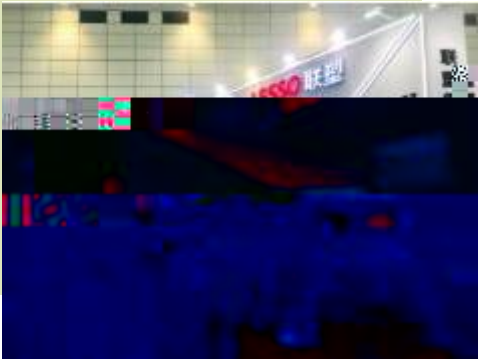



目录





开发





()

